

Interwoven Eco-Panels

In Stock 

Linear yet dimensional, **Interwoven Eco-Panels** provide a canvas of layers and textures for feature and focal walls. The panels are offered in a range of species in rich, natural colorations with a seamless interlocking installation. This modern, fresh product is also sustainable.

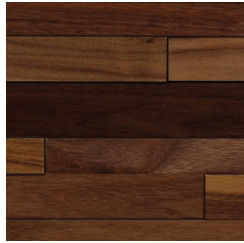

WPVEP017



WPVEP042



WPVEP043



WPVEP044



WPVEP066

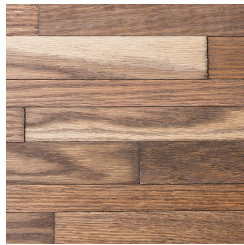

WPVEP047

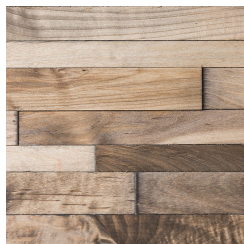

WPVEP046



Nordstrom Century City - Bar Verde, Los Angeles, CA
Architecture and Light
Featuring Interwoven Eco-Panels - WPVEP017

View collection web page for the complete offering including additional product options, corresponding Spec ID# and updates.

SPECIFICATIONS

SIZE: WPVEP017, WPVEP066, WPVEP047, WPVEP046: 13.5" x 53.5"; WPVEP042-44: 12" x 60"

THICKNESS: 8.5mm and 10mm including backing

BACKING: 3.1mm Birch

FINISH: WPVEP017: UV Varnish, 10% Low Sheen; WPVEP042-WPVEP066: 100% Natural Danish Oil

SPECIES: WPVEP017: Walnut; WPVEP046: Maple; WPVEP047: Red Oak; WPVEP042-044: Mixed Species; WPVEP066: White Oak

INSTALLATION: Interlocking, Glue and Finishing Nails

PACKAGING: WPVEP017, WPVEP066, WPVEP047, WPVEP046: 5 SF per panel, 6 panels per box (30 SF per box);

WPVEP042-WPVEP044: 5 SF per panel, 5 panels per box (25 SF per box)

- Corner Moldings available; Contact sales@archsystems.com
- Lacey Act Compliant
- No VOC Emissions
- Can contribute to LEED®
- In Stock products are subject to availability
- Please note that variations in color and texture may occur due to the nature of the material

INSTALLATION METHOD

ASI | Architectural Systems, Inc. guarantees the conformity of its products when they are installed according to the installation instructions and are maintained in an environment where ambient humidity ranges between 35% and 55%: before, during and after installation. **LEAVE THE BOX IN THE ROOM IT IS TO BE INSTALLED FLAT ON THE FLOOR IN ITS ORIGINAL WRAPPING UNTIL INSTALLATION.**

PRECAUTIONS: Always wear work gloves and safety glasses when installing the product.

INSTALLATION INSTRUCTIONS

TOOLS:

- Vertical adhesive through ASI
 - Spec ID# FLDTTC025
- Caulking gun
- Electric mitre saw
- Tablesaw
- Level
- Measuring tape
- Cutter
- Pneumatic finish hammer (#23 gauge finish nail)
- Stepladder

MAKE SURE YOUR KNIVES AND SAW-BLADES ARE IN PRIME CONDITION.

First, check the wall(s) is level from floor to ceiling and edge-to-edge. If not, adjust accordingly.

STEP 1:

If you are using moldings, leave space accordingly around the perimeter of your installation area.

STEP 2:

Cut a minimum of 6" (15 cm) from the male side of your first panel, save the female cut section of the panel to start the wall.

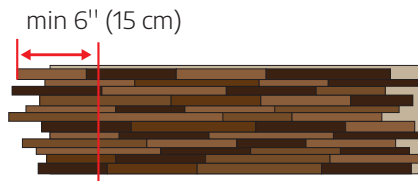

STEP 3:

B. Apply glue at the edges of each piece.



STEP 4:

Position the first panel at the lower left section of the wall in the adjustment area if you are using moldings.

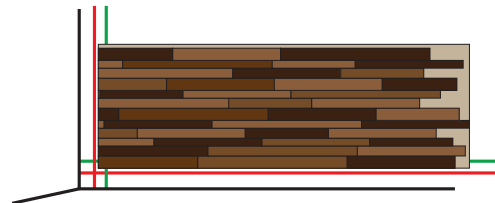

STEP 3:

A. Apply a line of vertical adhesive through ASI, Spec ID# FLDTTC025 in the form of a rectangle (1/2" (1.3 cm) from edges) and an X inside the rectangle.

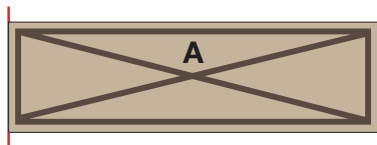

NOTE: If wood pieces detaches from a wall panel, reposition using vertical adhesive through ASI, Spec ID# FLDTTC025.

The wall panel needs to be glued and nailed for a successful install and to prevent future warping. Failure to comply with the installation instructions shall void the application of the warranty. This is a glue and nail installation. Do not install over material other than drywall and plywood.

INSTALLATION METHOD CONT.

STEP 5:

Nail the panel in place with #23 gauge finish nails on the contour lips and on the two bottom rows in angles between wood pieces. (Never nail directly on the face of the narrow wood pieces).

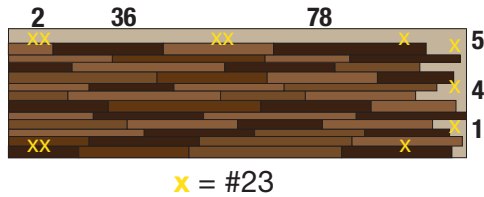

STEP 6: Installation of subsequent panels

- Repeat the gluing procedure
- Insert panel B into panel A
- Repeat the nailing procedure



STEP 7: End a row

Cut any excess of the wall panel to be flush with the edge of the wall.

STEP 8: Start a new row

Use the panel cut in Step 7 to begin the new row. Repeat Step 3, 4 and 5.

STEP 9: Last row

Cut the panels of the last row lengthwise to fit the given space. Allow enough space for the molding if necessary.

STEP 10:

Insert the molding in the reserved space set at the beginning of the installation if needed.

NOTE: If wood pieces detaches from a wall panel, reposition using vertical adhesive through ASI, Spec ID# FLDT025.

The wall panel needs to be glued and nailed for a successful install and to prevent future warping. Failure to comply with the installation instructions shall void the application of the warranty. This is a glue and nail installation. Do not install over material other than drywall and plywood.

MAINTENANCE

Clean-up recommendations: a regular dusting with a soft cloth or a feather duster.

WARRANTY

ASI | Architectural Systems, Inc. guarantees Interwoven Eco-Panels against manufacturing defects. If, upon opening a box, a panel is defective or fails to meet Architectural Systems, Inc. quality standards, the consumer may return the panel to ASI | Architectural Systems, Inc. for replacement.

This product is flammable and its use near an important heating source (such as a gas fireplace, solid burning appliances, slow burning stove) is not recommended. Please check the latest construction regulations or the nearest fire department in your locality. In most cases, the use of decorative wood walls is forbidden near these heating sources.

A panel with glue applied to its back or an installed panel (nailed) is deemed accepted and cannot be claimed under warranty. An unglued lamination may be glued back together using vertical adhesive through ASI, Spec ID# FLDTC025. Given the nature of wood, it is possible that Interwoven Eco-Panels may exhibit color variations from one panel to the next or from one production lot to the next. We recommend that you arrange the panels on the wall based on your personal color preferences. Such variations may not be claimed under warranty.

Before installing a panel, check the fit prior to spreading glue on the panel. If a panel fails to interlock properly, attempt to position it on a panel in another row. If the Interwoven Eco-Panel once again, fails to interlock properly, please return it to Architectural Systems, Inc. for replacement.

ASI | Architectural Systems, Inc. guarantees the conformity of its products when they are installed according to Interwoven Eco-Panels installation guidelines and are maintained in an environment where ambient humidity ranges between 37% and 45%. Failure to comply with installation and maintenance instructions and with recognized trade techniques could void the application of these warranties.

For questions regarding the interpretation of the warranty, contact ASI | Architectural Systems, Inc. sales@archsystems.com

TECHNICAL DATA

WPVEP042 & WPVEP044 - SPECIES AS FOLLOWS:

12 wood species: Red Oak, White Oak, Ash, Hickory, Walnut, Jatoba, Tigerwood, Sapele, Maple Birch, Silver Maple, Beech, Cherry.

Surface Burning Characteristics of Building Materials ASTM E84 - 14

Test Sample	Flame Spread Index (FSI)	Smoke Developed Index (SDI)
WPVEP017	110	140
WPVEP047	95	300
WPVEP046	120	175
WPVEP066	95	195
WPVEP042, 043 & 044	120	200
WPVEP082, 084 & 088	75	350
WPVEP186	125	140
WPVEP287	100	175
WPVEP288	130	120
WPVEP142 & 143	90	400
WPVEP141	70	400
Hybrid Barn Wood Panels	n/a	n/a

- Flame spread / Smoke developed Index is the result (or the average of the results of multiple tests), rounded to the nearest multiple of 5. Smoke developed results in excess of 200 are rounded to the nearest multiple of 50.

CLASSIFICATION	FSI	SDI
CLASS A or I	0 - 25	0 - 450
CLASS B or II	26 - 75	0 - 450
CLASS C or III	76 - 200	0 - 450

TECHNICAL DATA CONT.

WPVEP017, WPVEP047, WPVEP046, WPVEP066

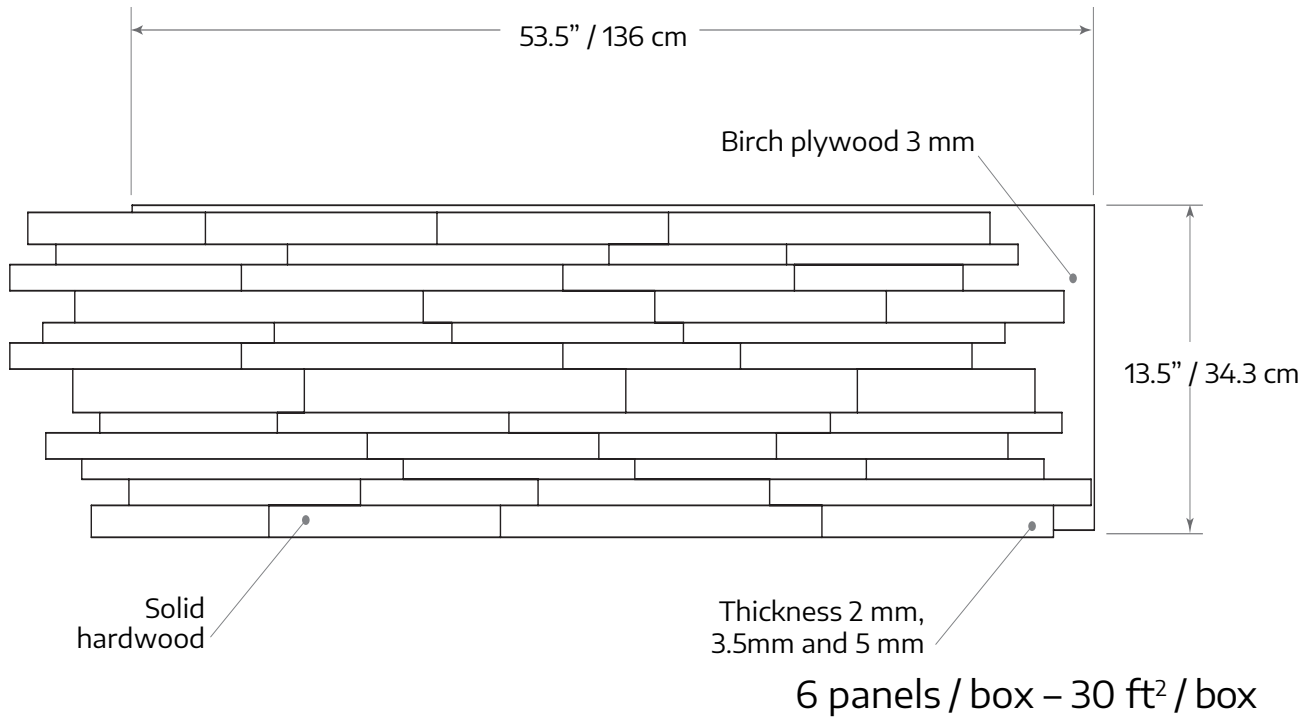

WPVEP042, WPVEP043, WPVEP044

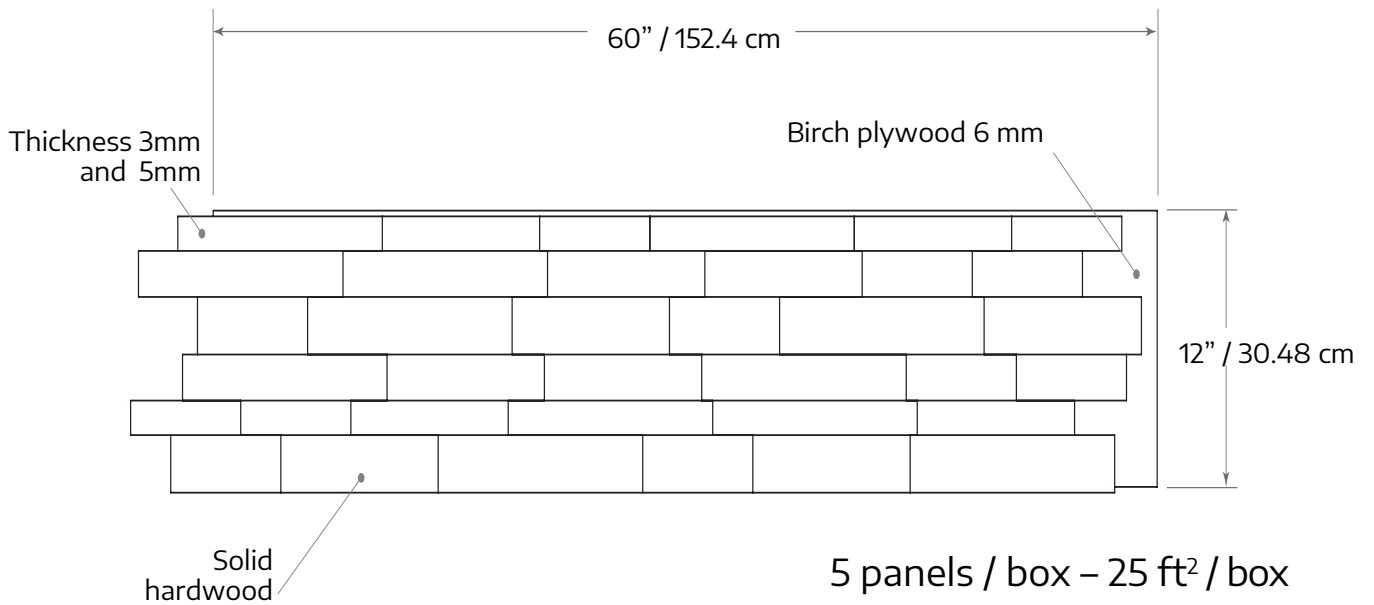

TECHNICAL DATA CONT.

TRIM PIECES

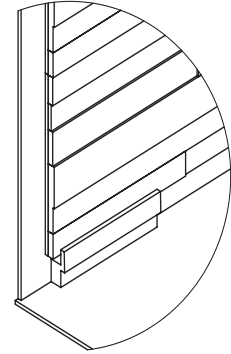
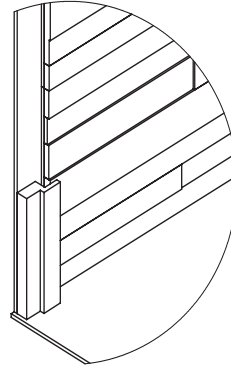
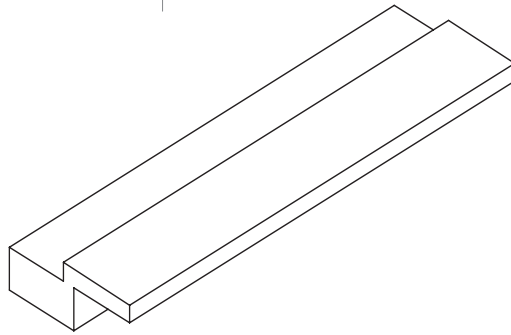
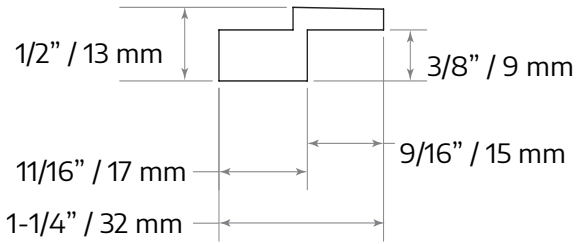

Ø 1/2 B 1/2

Ø 1/2 B 1/2



Ø 1/2 B 1/2

Ø 1/2 B 1/2



Ø 1/2 B 1/2

Ø 1/2 B 1/2



Ø 1/2 B 1/2

Ø 1/2 B 1/2

TRIM PIECES

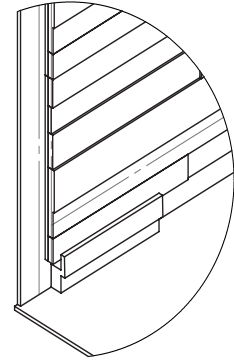
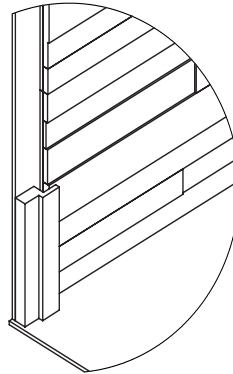
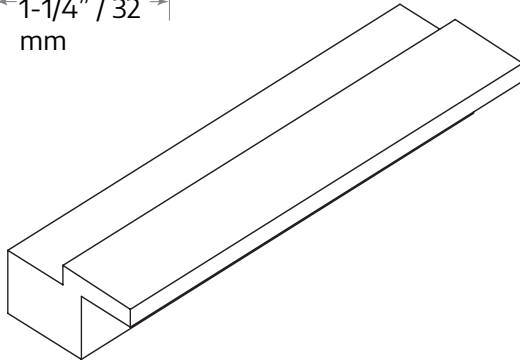
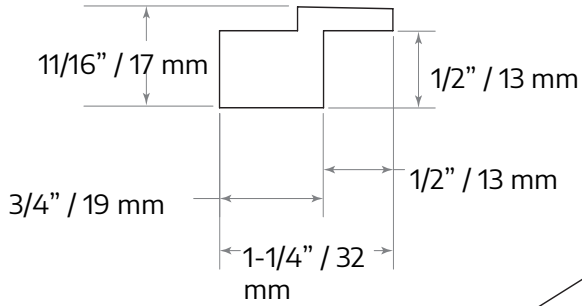

Ø 1/2 B 1/2

Ø 1/2 B 1/2



Ø 1/2 B 1/2

Ø 1/2 B 1/2



Ø 1/2 B 1/2

Ø 1/2 B 1/2